

ROTOPLAY®

PLAYGROUND COMPONENTS

ÉLÉMENTS D'AIRES DE JEUX

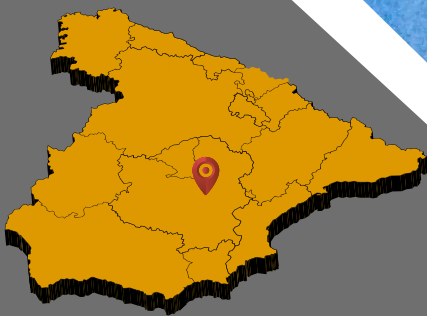

ABC ROTOMOLDEO
C/ San Cristóbal, 5
16440 Montalbo (CUENCA) - ESPAÑA

Tel.: +34 969 130 382
comercial@abcrotomoldeo.com



www.rotoplay.eu

RECYCLED MATERIAL MATÉRIAUX RECYCLÉS

We have incorporated a new range of recycled materials in all our own product line for playgrounds, with the objective of promoting and contributing to the care of the environment.

The mechanical properties of the new recycled materials are similar to the properties of materials made from virgin materials, while maintaining their durability and strength.

Nous avons incorporé une nouvelle gamme de matériaux recyclés dans toute notre ligne de produits pour aires de jeux, dans le but de promouvoir et de contribuer à la protection de l'environnement.

Les propriétés mécaniques des nouveaux matériaux recyclés sont similaires à celles des matériaux fabriqués à partir de matières vierges, tout en conservant leur durabilité et leur résistance.

Colours/Couleurs

30% RECICLADO VERSION/ VERSION 30% RECYCLÉE

The 30% Recycled version is made up of material from waste generated from tetrabriks (30%) and polyethylene (70%).

La version 30% Recyclée est composée de matériaux issus de déchets générés à partir de tetrabriks (30%) et de polyéthylène (70%).

RAL
5001



RAL
6026



PURE RECYCLED VERSION/ VERSION PURO RECYCLÉE

The 100% recycled version is composed entirely of PE from industrial post-consumer material.

La version 100% recyclée est entièrement composée de PE issu de matériaux industriels post-consommation.

RAL
2010



RAL
7012



RAL
9011



RICE HUSK VERSION/ VERSION COQUES DE RIZ

The Rice Husk version is manufactured with a material composed of 15% plant-based material (rice husks) and 85% Polyethylene.

La version Rice Husk est fabriquée avec un matériau composé de 15% de matière végétale (coques de riz) et de 85% de polyéthylène.

RAL*

-



*Due to the natural components, this colour may show speck and uneven colour.
*À cause des composants naturels présents, cette couleur peut avoir des traces et manque d'uniformité.





Our T-series are a range of straight slides fully adaptable to any structure since we have a different model for most heights.
There is also a unique ecological range of slides available called T-SERIES ECO RANGE.

La série T est une gamme de toboggans droits qui s'adaptent à n'importe quelle structure puisque il existe un modèle pour chaque hauteur.
Il est aussi disponible une gamme de toboggans écologiques, unique dans le secteur appelée SÉRIET GAMME ECO.

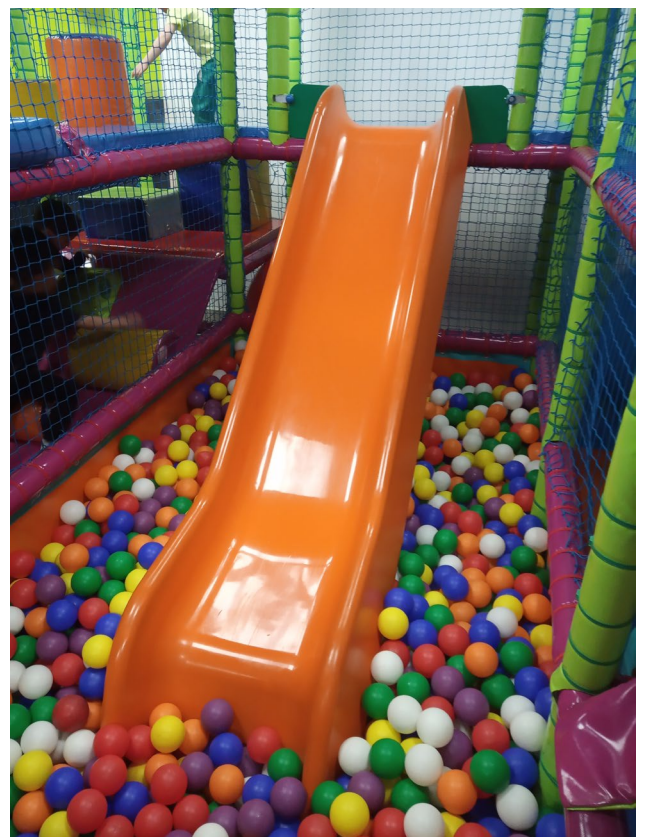

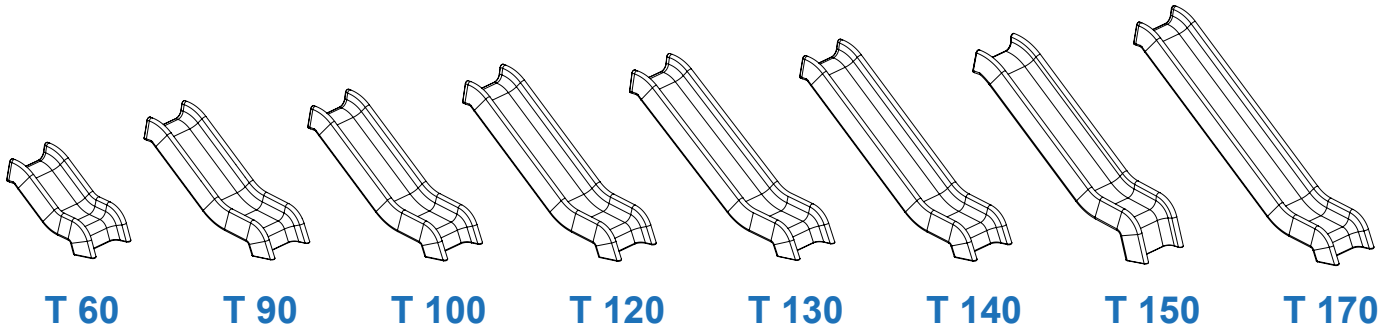

AVAILABLE MODELS MODÈLES DISPONIBLES	Height	Length	Width	Slope	Free distance of safety Distance de sécurité	
	Hauteur	Longueur	Largeur	Pendant	Ra	B
T 60	600	1.115	657	39°	1.500	1.500
T 90	900	1.660	657	39°	1.500	1.500
T 100	1.000	1.784	657	39°	1.500	1.500
T 120	1.200	2.030	657	39°	1.500	2.000
T 130	1.300	2.154	657	39°	1.500	2.000
T 140	1.400	2.279	657	39°	1.500	2.000
T 150	1.500	2.243	657	39°	1.500	2.000
T 170	1.700	2.648	657	39°	1.500	2.000

Dimensions in millimeters.
Dimensions en mm

Ra → Fall radius area on the highest point of the slide.
Rayon du secteur de chute depuis le point le plus haut du toboggan.

B → Length of the impact area.
Longueur du secteur d'impact.

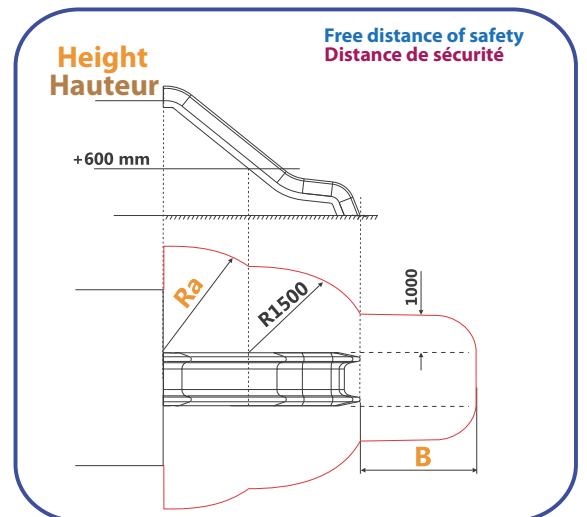
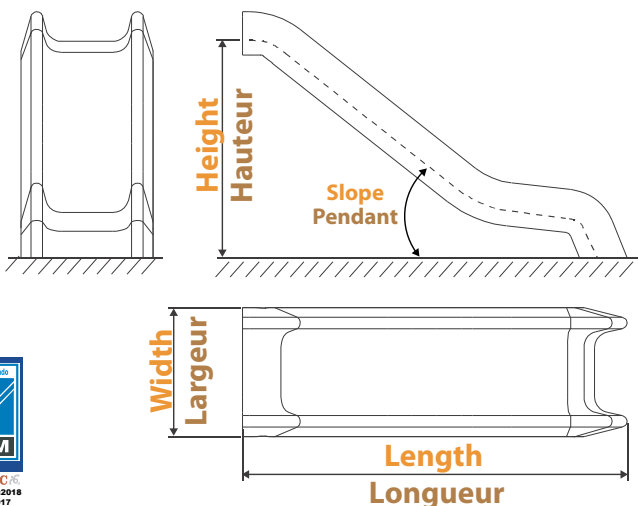

Colours/Couleurs

Virgin PE/ PE Vierge



Eco Range / Gamme Eco

T SERIES SLIDES 30% RECYCLED/ TOBOGGANS SÉRIE T 30% RECYCLÉE

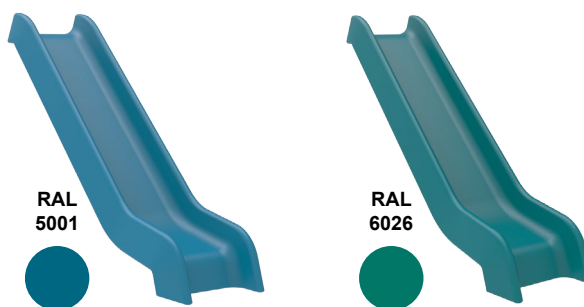

PURE RECYCLED T SERIES SLIDES/ TOBOGGANS SÉRIE T "PURE RECYCLED"



ECO-T SERIES SLIDES/ TOBOGGANS SÉRIE ECO-T



*Due to the natural components, this colour may show speck and uneven colour.
*À cause des composants naturels présents, cette couleur peut avoir des traces et manque d'uniformité.



Screwed inserts: M10

Insérés filetés: M10

Area for vertical closing, with screwed inserts, integrated into the slide for its installation.

Zone pour fermeture verticale, avec insérés filetés, intégrés dans le toboggan pour son installation.



Area of horizontal support, with screwed inserts, for its installation. Design totally reinforced by its longitudinal interior nerves.

Zone d'appui horizontal avec insérés filetés, pour son installation. Design totalment renforcé grâce aux nerfs longitudinaux intérieurs.

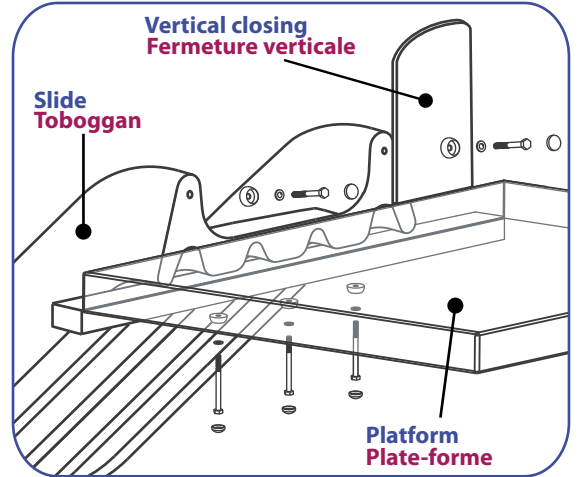

How to fix it to the platform

Exemple d'installation sur la plate-forme

Two ways of installation: Deux types d'installations:

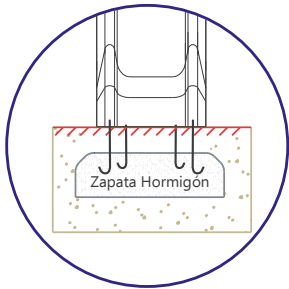

With foundations, on non-compact grounds

Deux fondations, dans des sols non compacts.

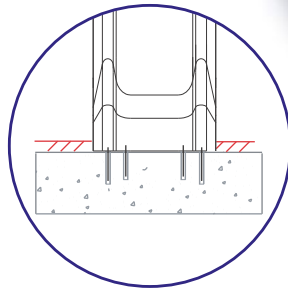

Fixed with a chemical plug, on compact grounds.

Fixés avec tampons chimique dans des sols compacts.

Stacking pallet
10 Units

Empilables pallet
10 Unités

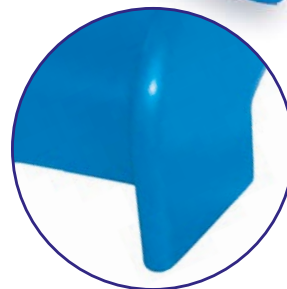
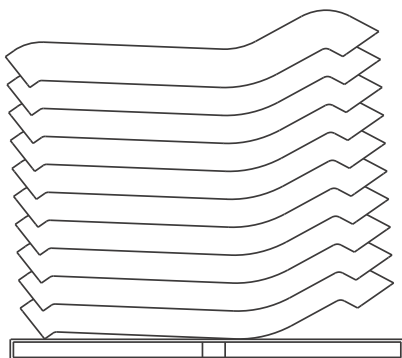

It includes screwed inserts in the base to fix the slide with all safety.

Insérés filetés inclus dans la base pour fixer le toboggan en toute sécurité.

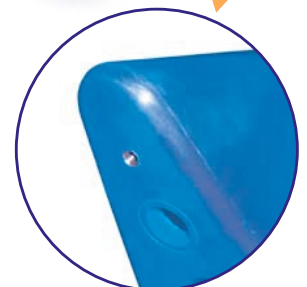

Highest security: Continuous surface and completely rounded edges.

Sécurité maximale: Surface continue et coins totalement arrondis.

TUBULAR SLIDE SECTIONS MODULES POUR TOBOGGANS TUBULAIRES



Tubular slide sections for assembly. Available in several colours*.
Recommended to follow international standard **UNE-EN 1176-3**.

Modules pour assemblage de toboggans tubulaires. Disponibles en différentes couleurs.
Il est recommandé de suivre les indications de la norme **UNE-EN 1176-3**.

Straight Section, 1000 Section droite 1000

Virgin PE/ PE Vierge

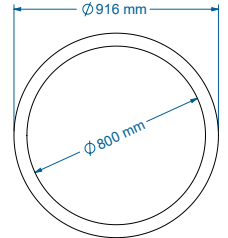
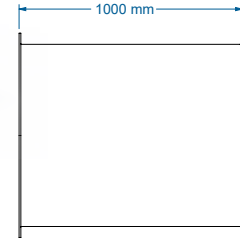
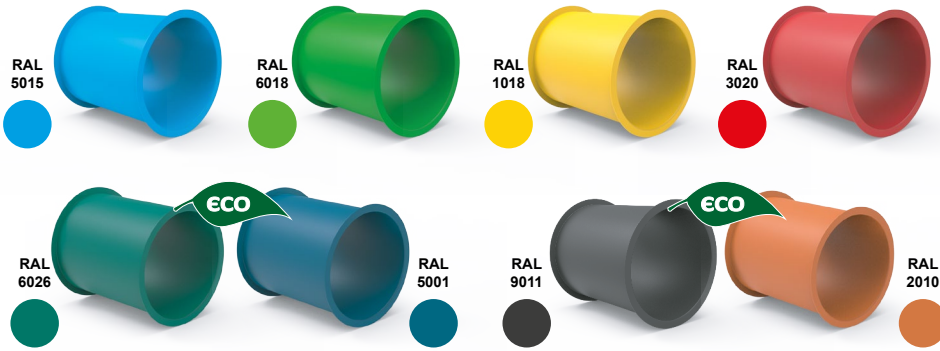

30% Recycled
Recyclé 30%

100% Recycled
Recyclé 100%

Straight Section, 500 Section droite 500

Virgin PE/ PE Vierge

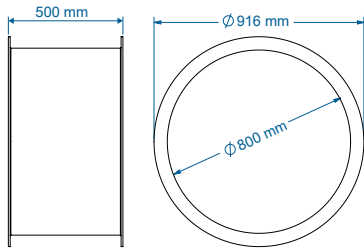
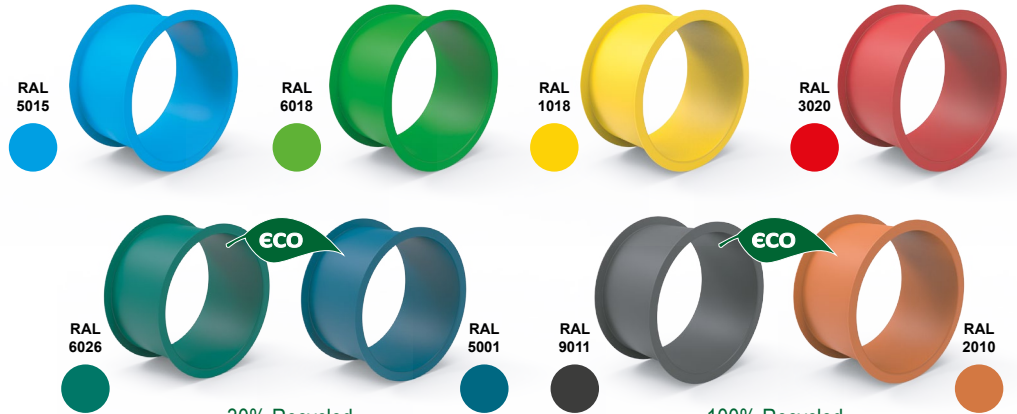

30% Recycled
Recyclé 30%

100% Recycled
Recyclé 100%

Tubular 30° elbow Section coude 30°

Virgin PE/ PE Vierge

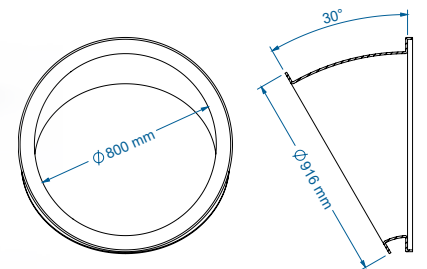
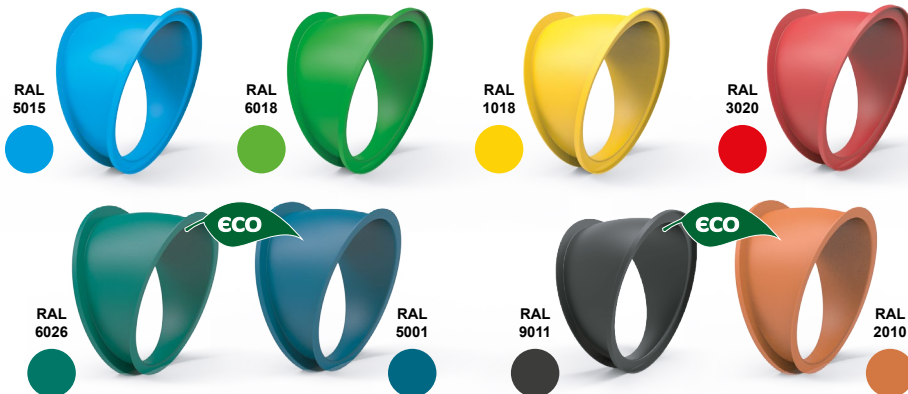

30% Recycled
Recyclé 30%

100% Recycled
Recyclé 100%

TUBULAR SLIDE SECTIONS MODULES POUR TOBOGGANS TUBULAIRES



Tubular 45° elbow
Section coude 45°

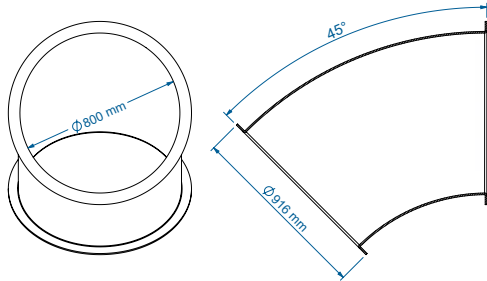

Virgin PE/ PE Vierge

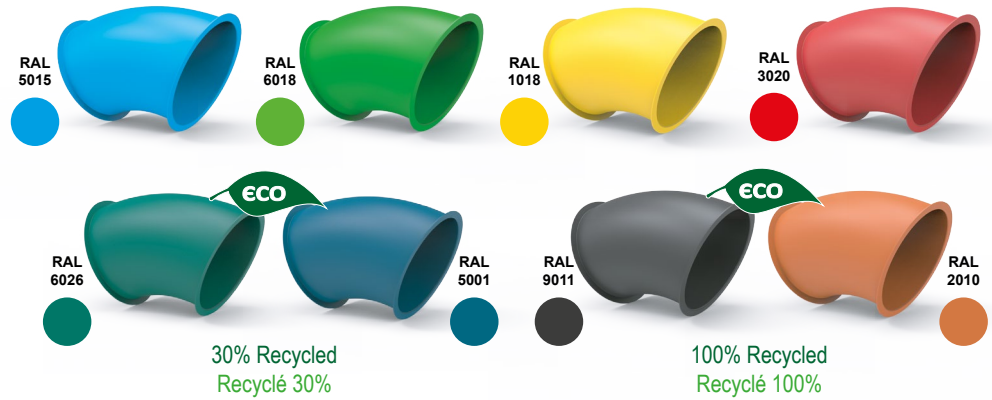

Tubular output section
Bouche de sortie

Virgin PE/ PE Vierge

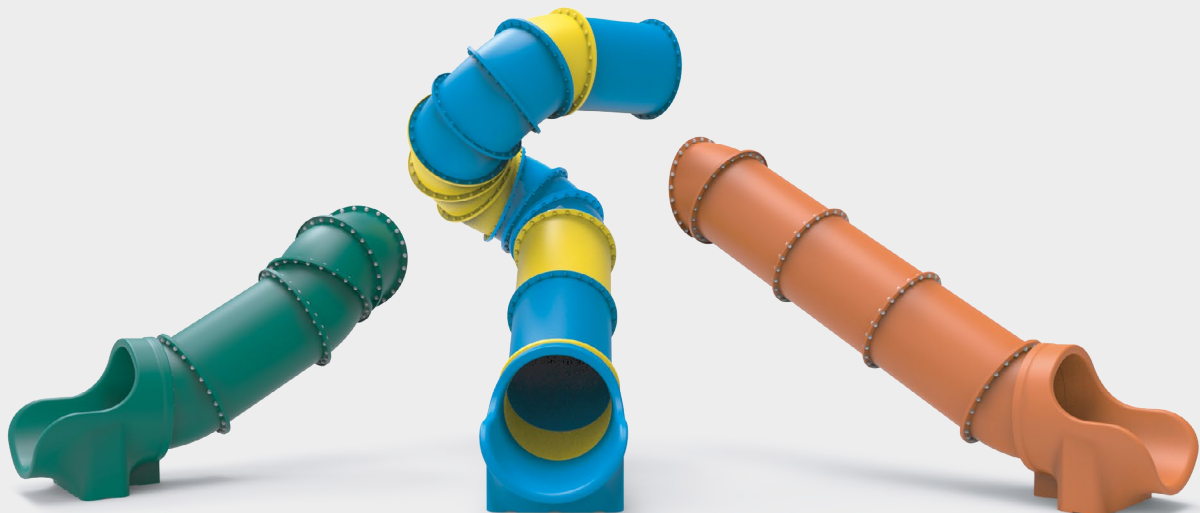

ASSEMBLY EXAMPLES EXEMPLE D'ASSEMBLAGES



Developments on demand
Développements sur mesure



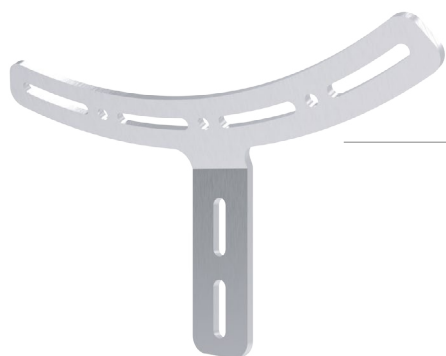

Bracket

Support made of stainless steel ideal to support any tube slide development.

Support en acier inoxydable idéal pour soutenir tout développement de toboggan tubulaire.

Support / Appui

Available in different heights

Disponible en différentes hauteurs

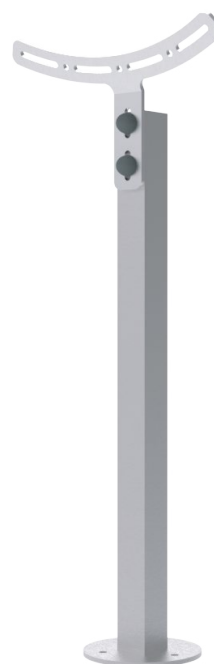

Screws and security caps **Visses et bouchons de sécurité**

SWING SEAT SIÈGE DE BALANÇOIRE



INCLUSIVE SWING SEAT SIÈGE INCLUSIF DE BALANÇOIRE



BIG



Inclusive Swing Seat with retention system designed according to EN 1176-1:2017.

Siège à balançoire inclusif avec système de rétention de sécurité dessiné conçu selon la norme EN1176-1:2017.

Recommended age: 5-14 years.
Maximum load: 120 kg
Use under adult supervision

Âge recommandé: 5-14 ans
Charge maximale: 120 Kg
Utiliser sous la surveillance d'un adulte

Available models Modèles disponibles

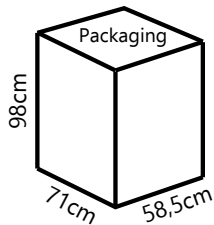
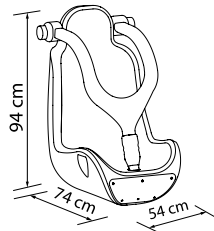

Individual box weight
Poids boîte individuelle

Note:

Can be supplied with or without chains. For the option with chains, these can be Long or Short.

Note:

Il est possible de le fournir avec ou sans chaînes. Pour l'option avec chaînes, celles-ci peuvent être Longues ou Courtes.

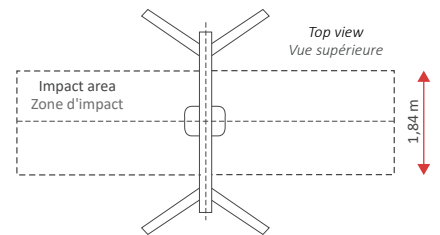
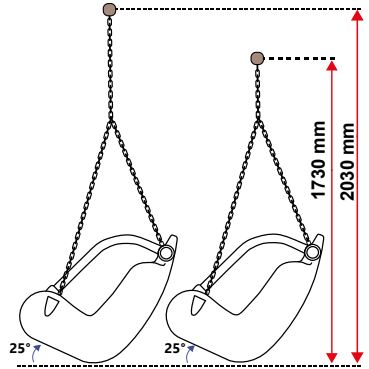

For short chains = 6,84 m Pour longues chaînes = 6,84 m
For long chains = 7,36 m Pour chaînes courtes = 7,36 m

INCLUSIVE SWING SEAT SIÈGE INCLUSIF DE BALANÇOIRE



BIG

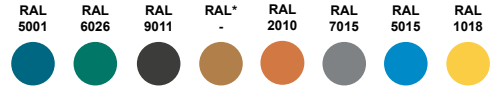

*Due to the natural components, this colour may show speck and uneven colour.
*À cause des composants naturels présents, cette couleur peut avoir des traces et manque d'uniformité.

WITH HARNESS / AVEC HARNAIS

WITHOUT CHAINS /
SANS CHÂÎNES



WITH SHORT CHAINS /
AVEC CHÂÎNES COURTES

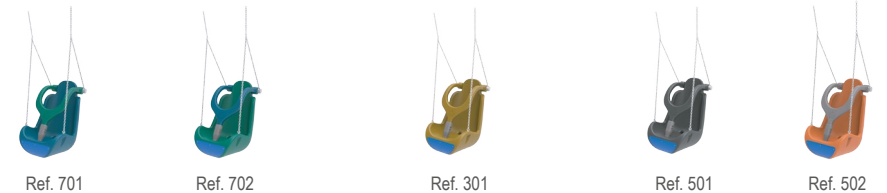

WITH LONG CHAINS /
AVEC CHÂÎNES LONGUES

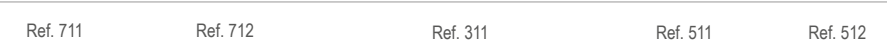

WITH BELT / AVEC CEINTURES

WITHOUT CHAINS /
SANS CHÂÎNES



WITH SHORT CHAINS /
AVEC CHÂÎNES COURTES

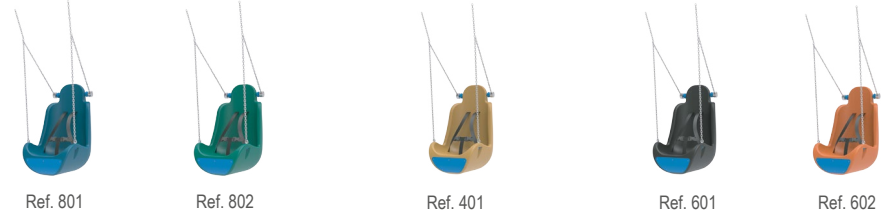

WITH LONG CHAINS /
AVEC CHÂÎNES LONGUES

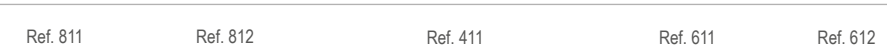

WITH SHORT CHAINS /
AVEC CHÂÎNES COURTES

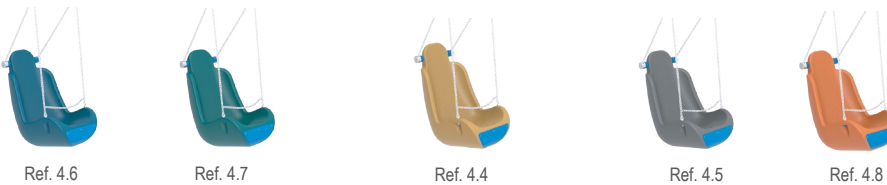

WITH LONG CHAINS /
AVEC CHÂÎNES LONGUES



WITH HARNESS + BELT / AVEC HARNAIS + CEINTURES

With harness + belts and without chains
Avec harnais + ceintures et sans chaînes

With harness + belts and short chains
Avec harnais + ceintures et chaînes courtes

With harness + belts and long chains
Avec harnais + ceintures et chaînes longues

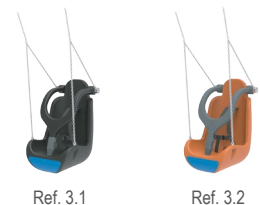
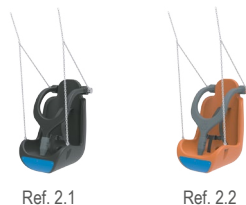

INCLUSIVE SWING SEAT SIÈGE INCLUSIF DE BALANÇOIRE



BROWNIE



Inclusive Swing Seat with retention system designed according to EN 1176-1:2017.

Siège à balançoire inclusif avec système de rétention de sécurité conçu en accord à la norme EN 1176-1:2017.

**Recommended age: 3-8 years.
Maximum load: 80 kg
Use under adult supervision**

**Âge recommandé: 3-8 ans
Charge maximale: 80 Kg
Utiliser sous la surveillance d'un adulte**

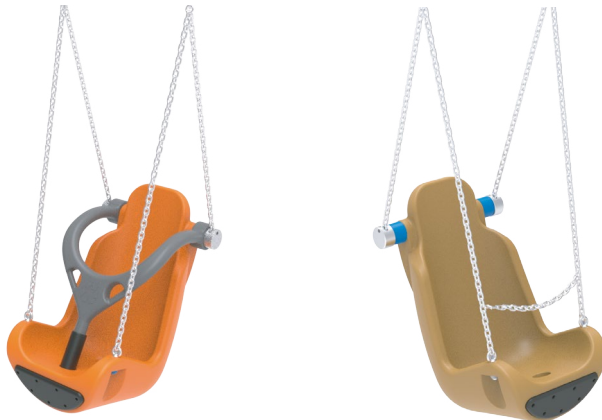

Available models Modèles disponibles

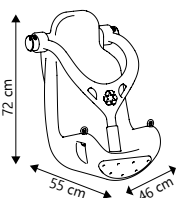

*Individual box weight
Poids boîte individuelle*

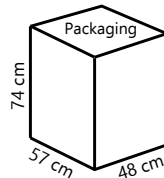

Note:

Can be supplied with or without chains. For the option with chains, these can be Long or Short.

Note:

Il est possible de le fournir avec ou sans chaînes. Pour l'option avec chaînes, celles-ci peuvent être Longues ou Courtes.

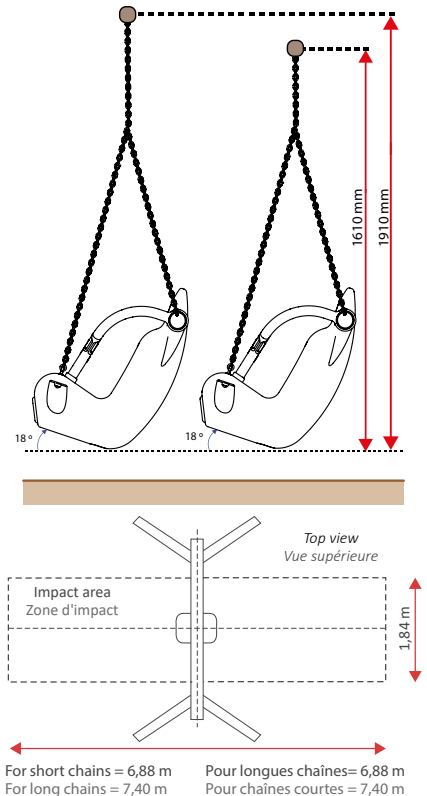

SWING SEAT SIÈGE DE BALANÇOIRE BIRD NEST NID D'OISEAU



Bird Nest Swing Seat designed according to EN 1176-1:2017. Suitable for accessible parks according to order TMA/851/2021.

Siège de balançoire nid d'oiseau conçu selon la norme EN 1176-1:2017. Convient aux parcs accessibles selon le décret TMA/851/2021.

Recommended age: 3-14 years
Maximum load: 280 kg
Max. 2 users
Use under adult supervision

Âge recommandé: 3-14 ans
Charge maximale: 280 kg
2 utilisateurs maximum
Utiliser sous la surveillance d'un adulte



Multi-user seat
Siège multi-utilisateurs

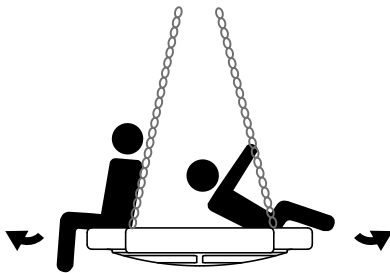

Security chain
Chaîne de sécurité



Universal accessible
Accès universel

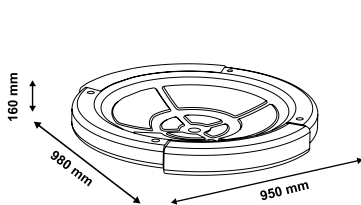
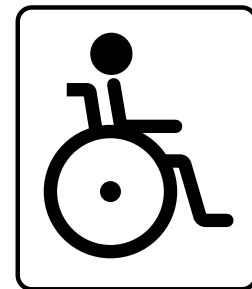

12,7 kg
With short chains
Siège chaînes courtes

16,5 kg
With long chains
Siège chaînes longues

Individual box weight
Poids boîte individuelle

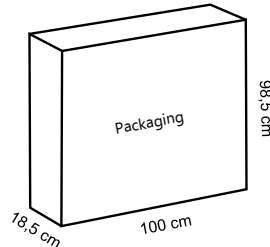

Note:

Can be supplied with Long or Short chains.

Note:

Il est possible de le fournir avec Longues ou Courtes.

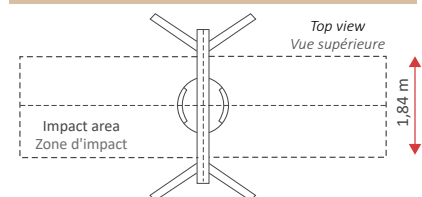
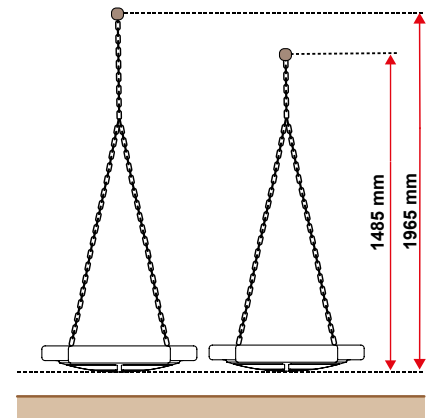

For short chains = 6,84 m Pour longues chaînes = 6,84 m
For long chains = 7,36 m Pour chaînes courtes = 7,36 m

INCLUSIVE SWING SEAT SIÈGE INCLUSIF DE BALANÇOIRE



BROWNIE

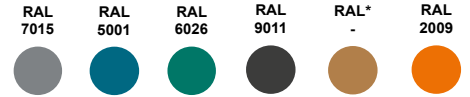

*Due to the natural components, this colour may show speck and uneven colour.
*À cause des composants naturels présents, cette couleur peut avoir des traces et manque d'uniformité.

WITH HARNESS / AVEC HARNAIS



Ref. 07 Ref. 08



Ref. 05



Ref. 06 Ref. 09

WITHOUT CHAINS /
SANS CHÂÎNES



Ref. 017 Ref. 018



Ref. 015



Ref. 016 Ref. 019

WITH SHORT CHAINS /
AVEC CHÂÎNES COURTES



Ref. 0117 Ref. 0118



Ref. 0115



Ref. 0116 Ref. 0119

WITH LONG CHAINS /
AVEC CHÂÎNES LONGUES

BROWNIE EASY



Ref. 8.6 Ref. 8.7



Ref. 8.4



Ref. 8.5 Ref. 8.8

WITH SHORT CHAINS /
AVEC CHÂÎNES COURTES



Ref. 7.6 Ref. 7.7



Ref. 7.4



Ref. 7.5 Ref. 7.8

WITH LONG CHAINS /
AVEC CHÂÎNES LONGUES

SWING SEAT SIÈGE DE BALANÇOIRE

BIRD NEST NID D'OISEAU

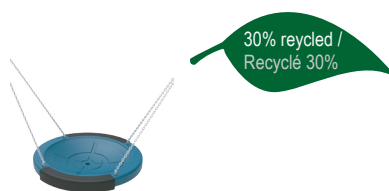

Ref. 10.1 Ref. 10.2



Ref. 10.3

WITH SHORT CHAINS /
AVEC CHÂÎNES COURTES



Ref. 11.1 Ref. 11.2



Ref. 11.3

WITH LONG CHAINS /
AVEC CHÂÎNES LONGUES

Rubber protection / Protection en caoutchouc

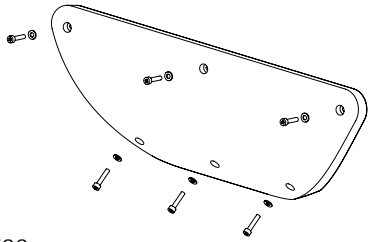

REF: 700

Harness / Harnais



REF: 702.4 ●
REF: 702.5 ●
REF: 702.6 ●
REF: 702.7 ●

Cylinders / Cilindres

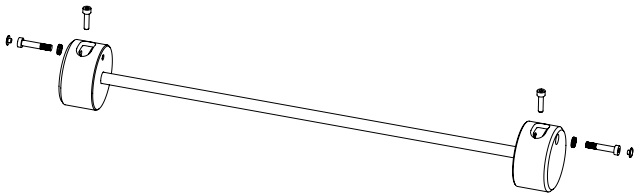

REF: 704 (Versión con Arnés)
REF: 7004 (Versión con Cinturones)

Long chains / Chaînes longues



REF: 706

Closure / Fermeture harnais

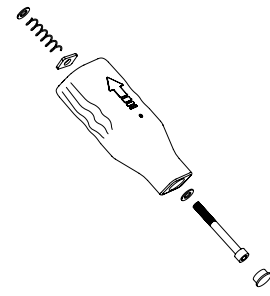

REF: 701.4 ●

Harness with closure / Harnais avec fermeture



REF: 703.4 ●
REF: 703.5 ●
REF: 703.6 ●
REF: 703.7 ●

Short chains / Chaînes courtes

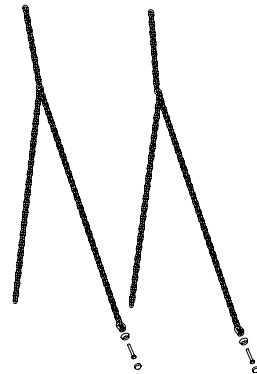

REF: 705

Belt / Ceinture

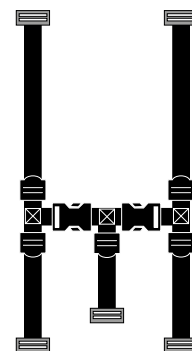

REF: 707

Rubber protection / Protection en caoutchouc

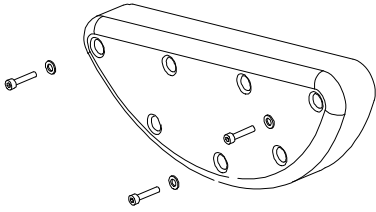

REF: 7000

Harness / Harnais

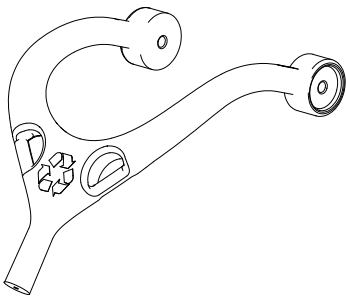

REF: 7002 ●

Cylinders / Cilindres

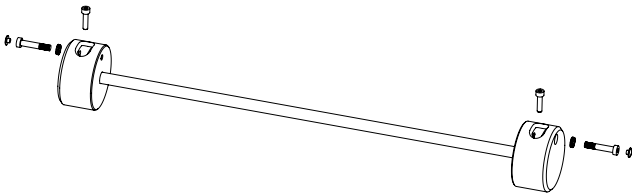

REF: 7004

Long chains / Chaînes longues

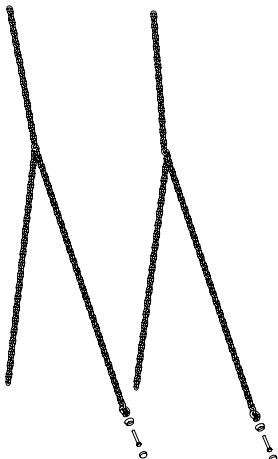

REF: 706

Closure / Fermeture harnais

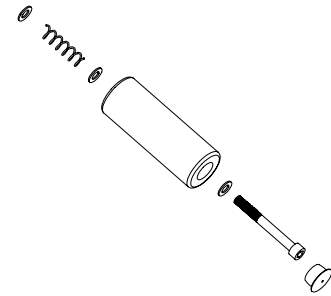

REF: 7001 ●

Harness with closure / Harnais avec fermeture

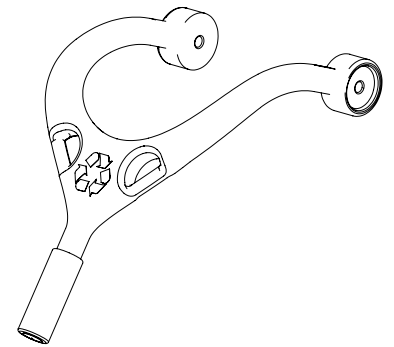

REF: 7003 ●

Short chains / Chaînes courtes

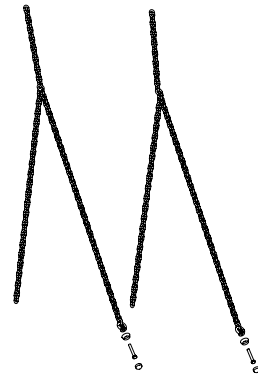

REF: 705